

Installation instructions for PZ4AL-02672-00, PZ4AL-02673-00 Under Run Reduction Gearbox Protective Shield

LEXUS NX



Model Year:

NX200T - 2014 -

NX200 - 2014 -

Vehicle Code:

AGZ15L-AWTLTW

ZGZ15L-AWXLPW

Part Number:

Steel: PZ4AL-02672-00
Aluminium: PZ4AL-02673-00



Weight:

Steel: 1,79 kg
Aluminium: 0,83 kg



Installation Time:

10 min

PZ4AL-02672-00, PZ4AL-02673-00

A

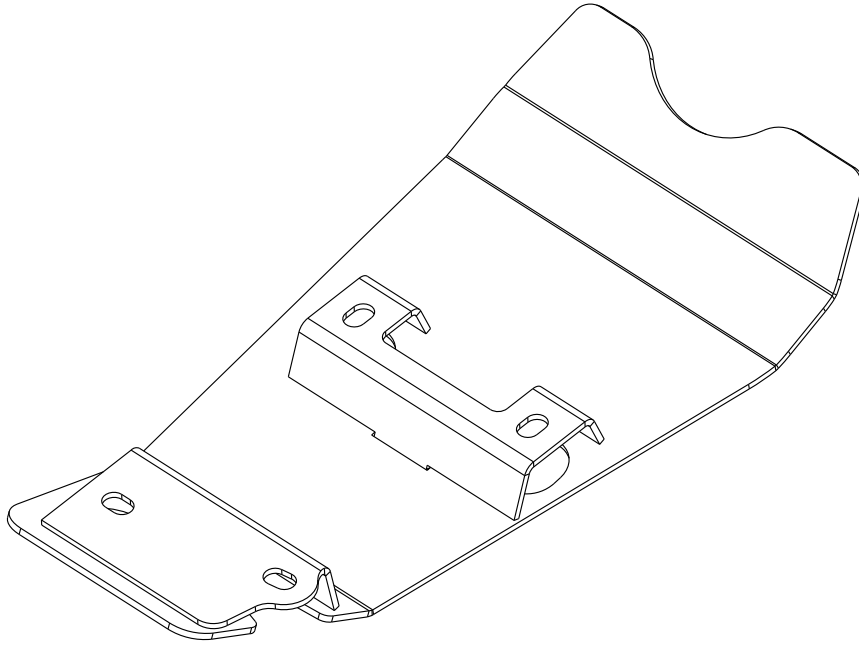

PZ4AL-08920-60

B

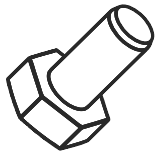

M8x20

4x

C1

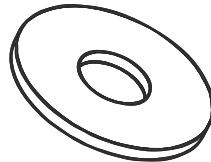

∅ 8

4x

C2

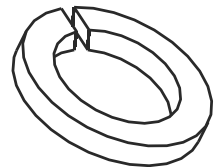

∅ 8G

4x

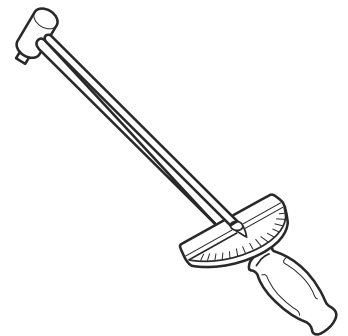
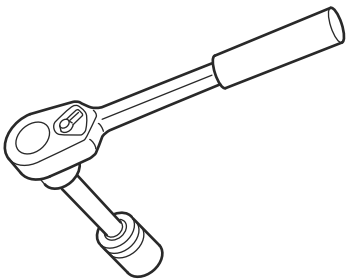

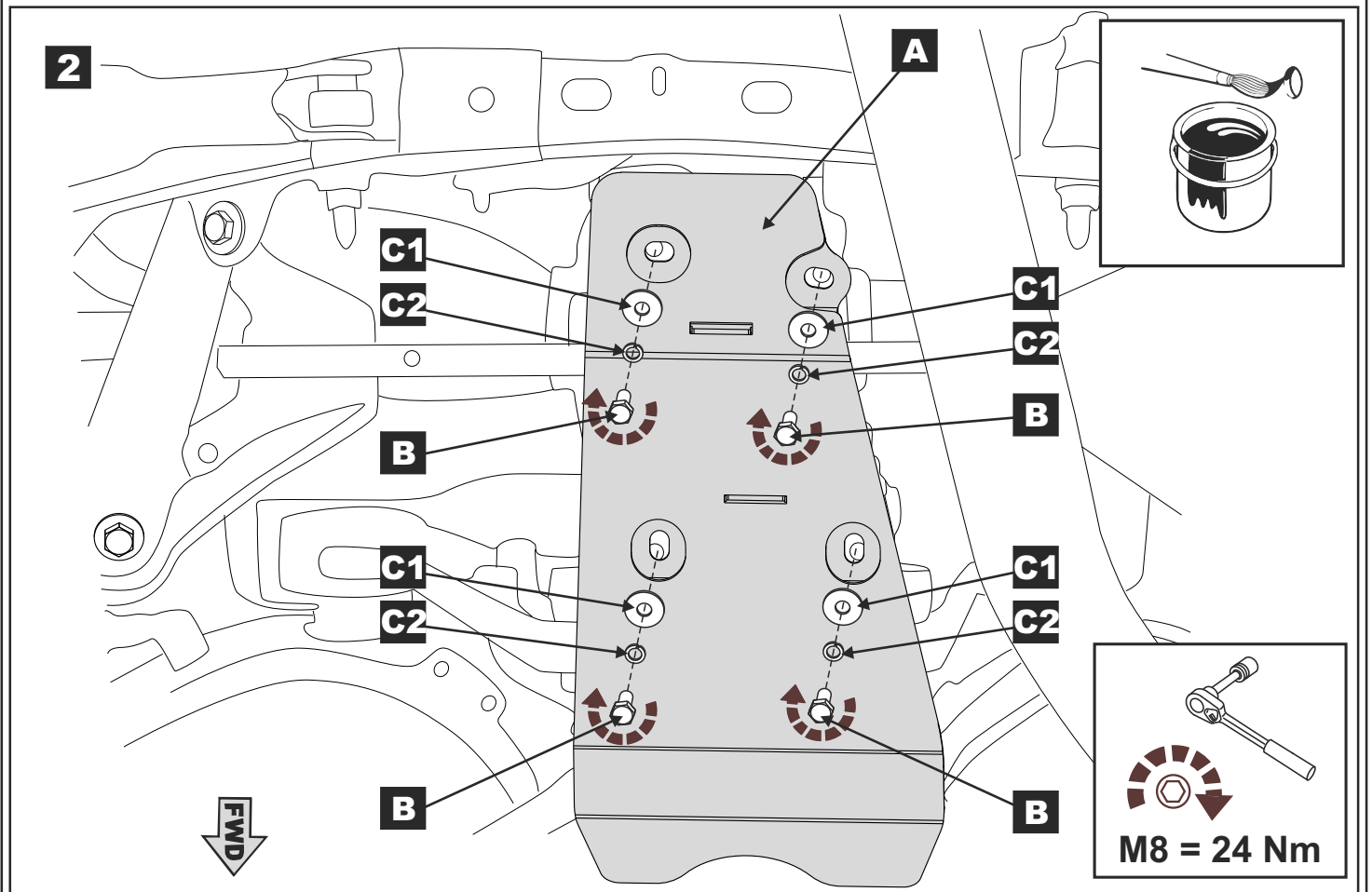
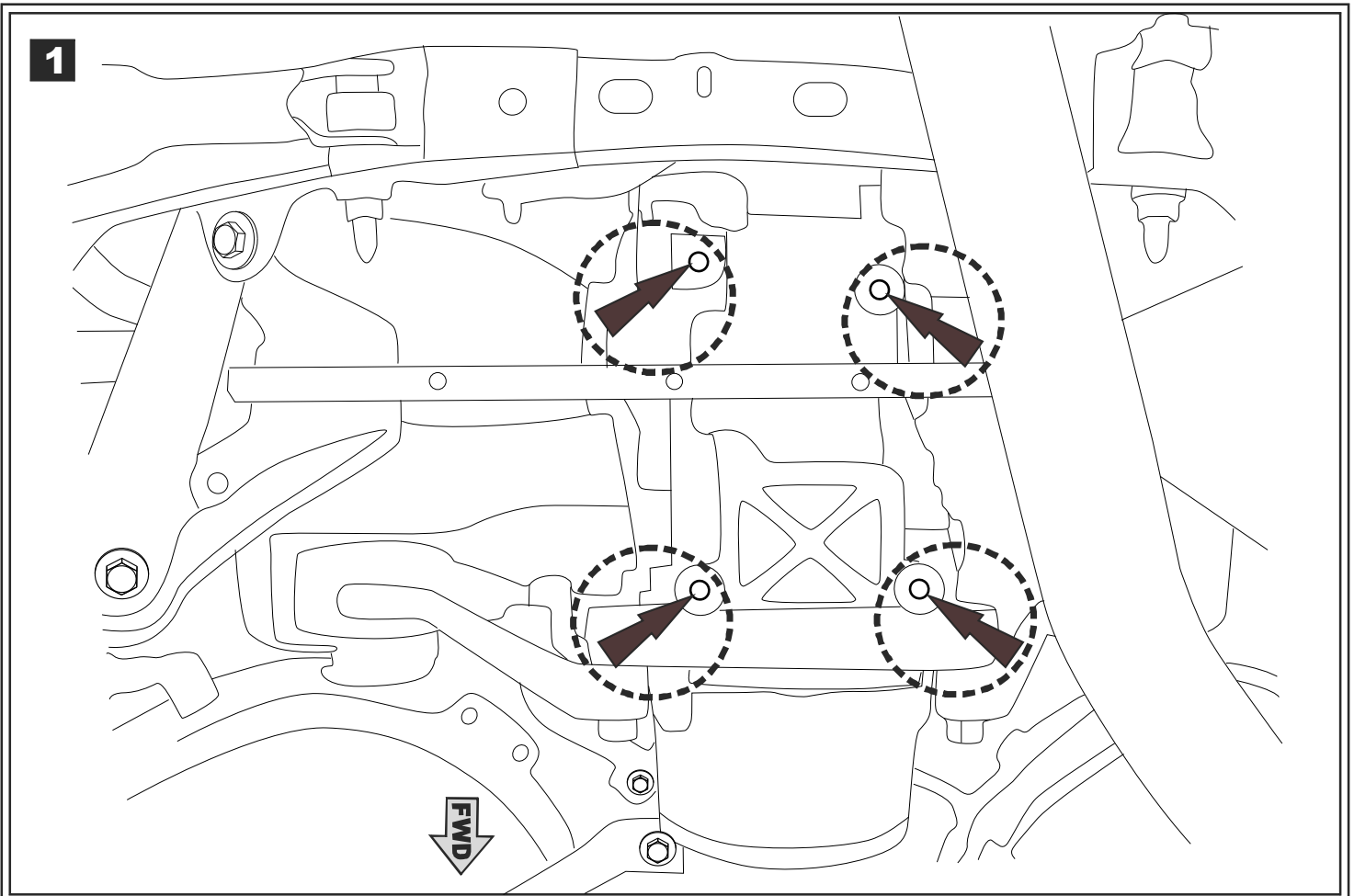

3

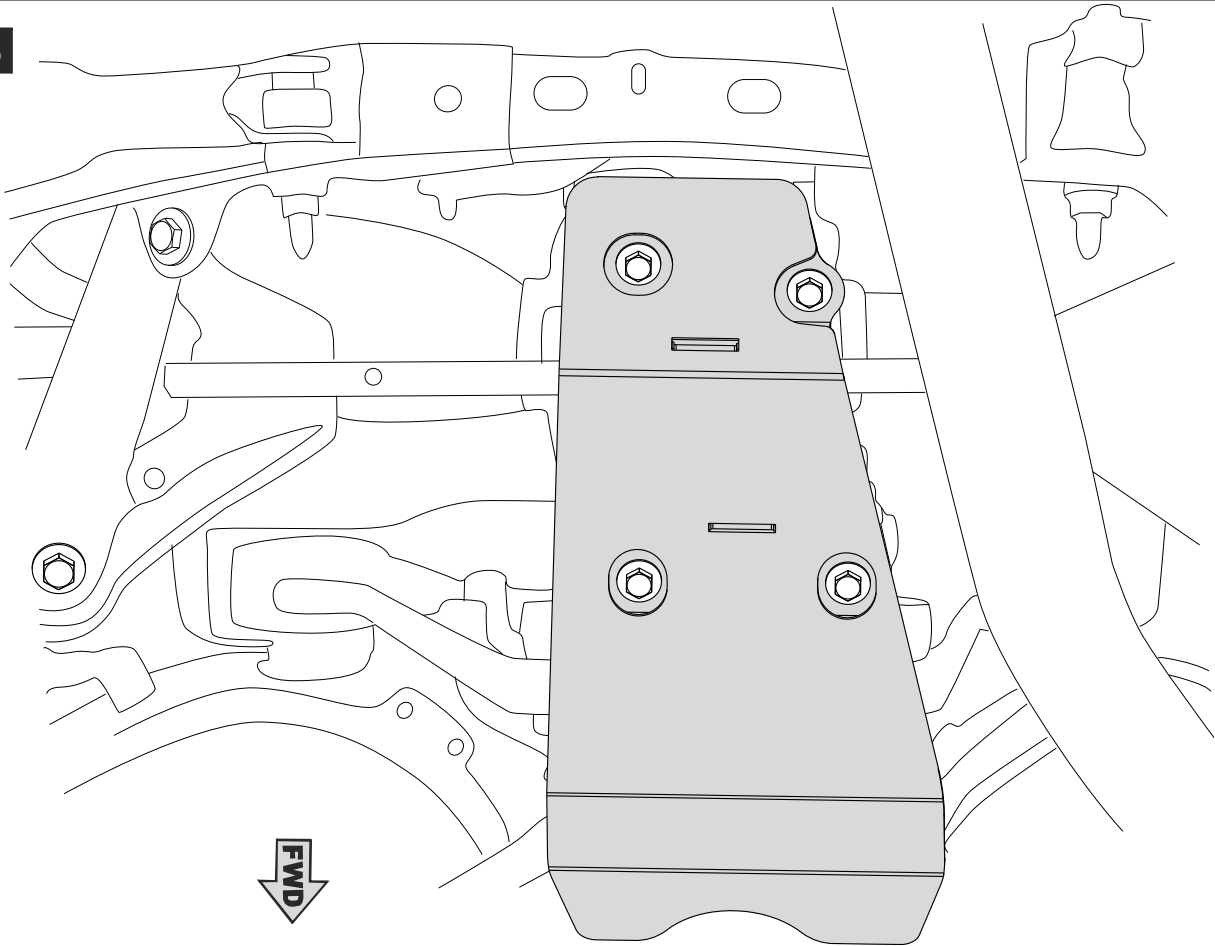

Part number:
PZ4AL-02672-00
PZ4AL-02673-00

Issue:
0

Date:
30/07/14

LEXUS NX 2014 -

Page:
4/4